

Power to the People - Residential PV-Battery Systems

Dr. Olaf Wollersheim

Competence E



Home Storage Market in Germany: Driven by Avoidance of Grid Supply

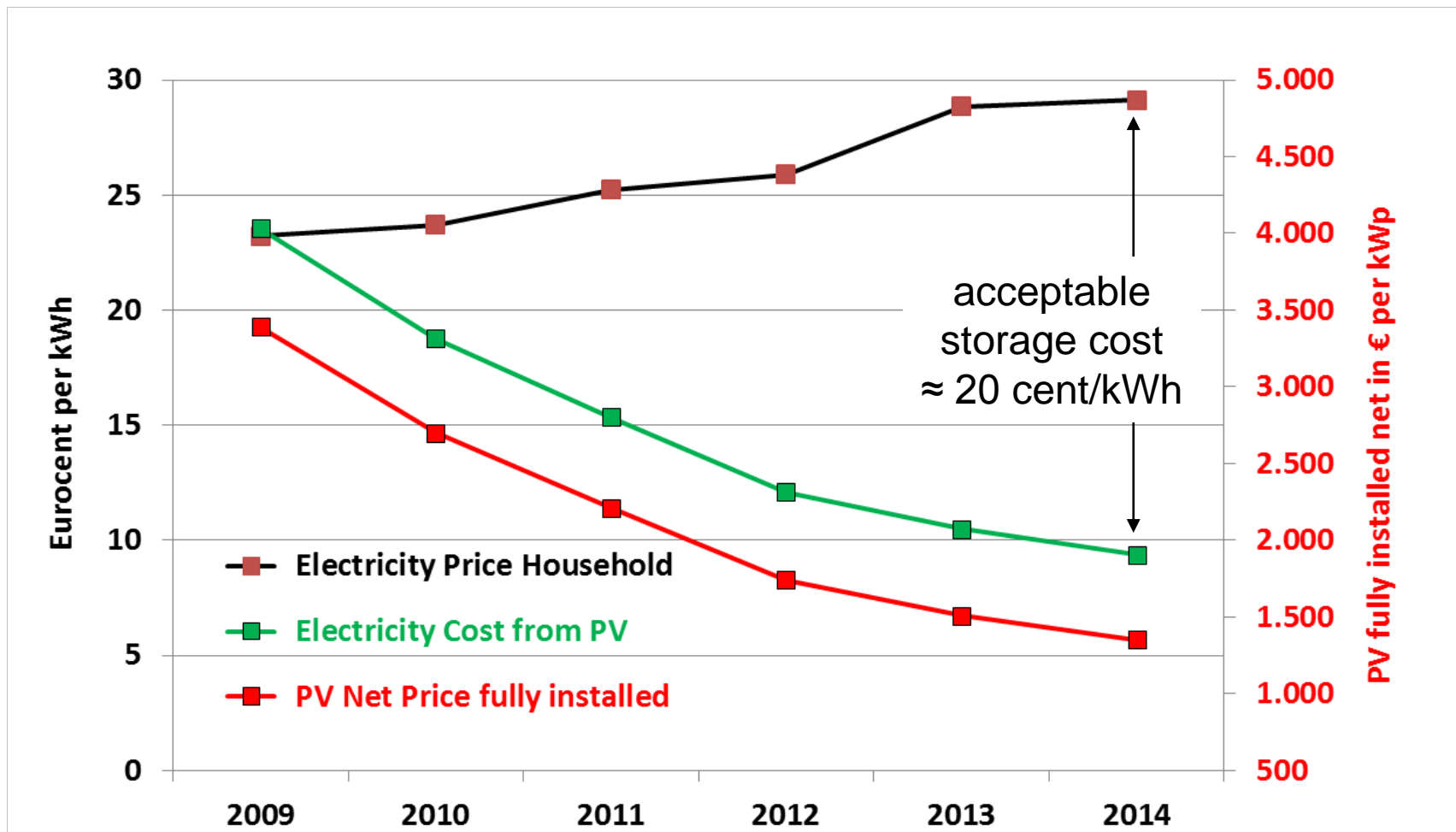

Source of data: BDEW, photovoltaic-guide.de

Price and Installation Forecasts Li-Ion Batteries

LI-ION BATTERY PACK COST FOR EV

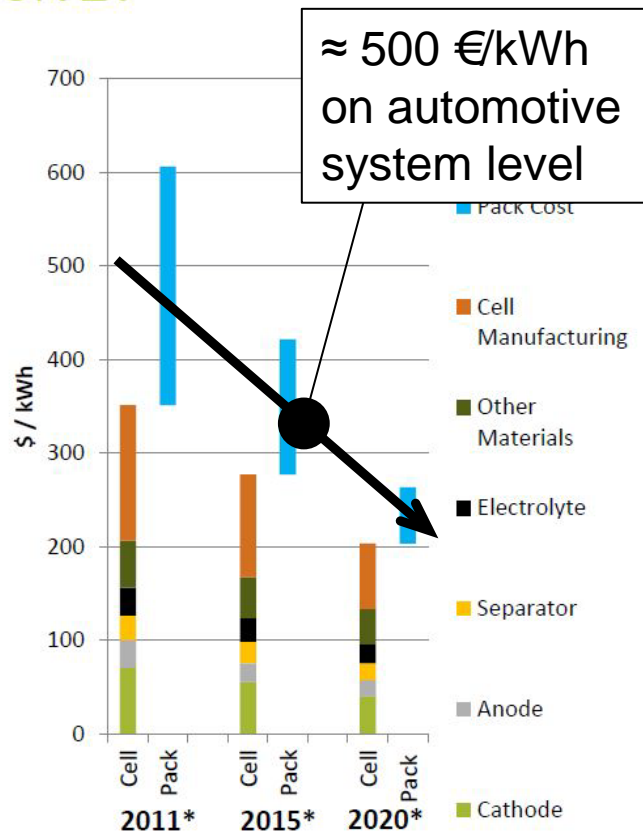

Newly installed LiB storage power [GW]

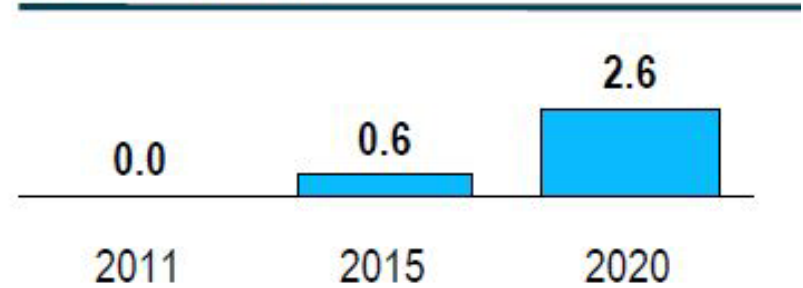

Source: Roland Berger, Batteries, Nice 2013

Source: Avicenne Energy, Batteries, Nice 2013

Decentralized Renewable Energy in Germany: The Future starts Right Now!

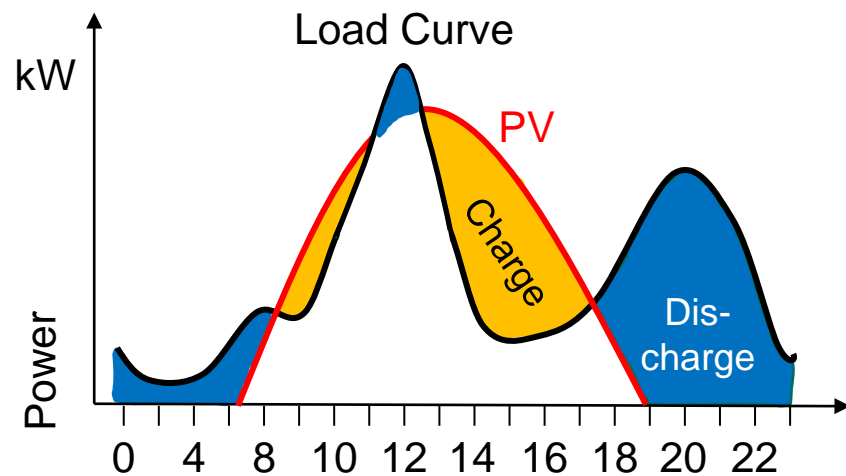
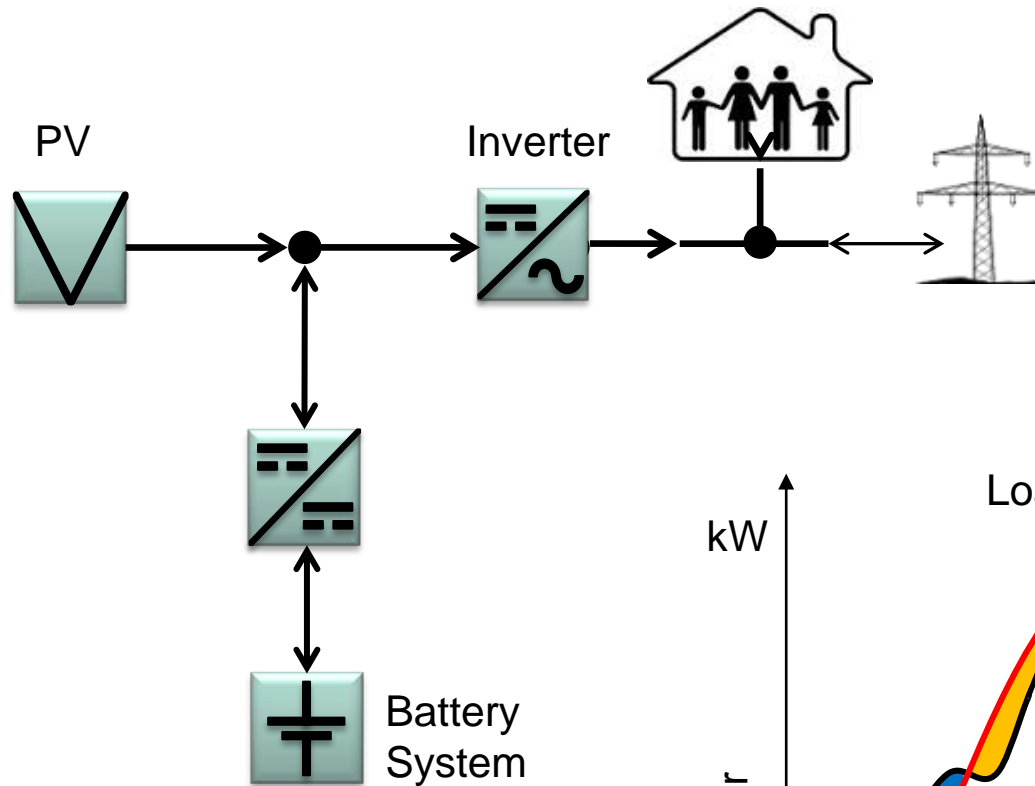

But what about Apartment Buildings?

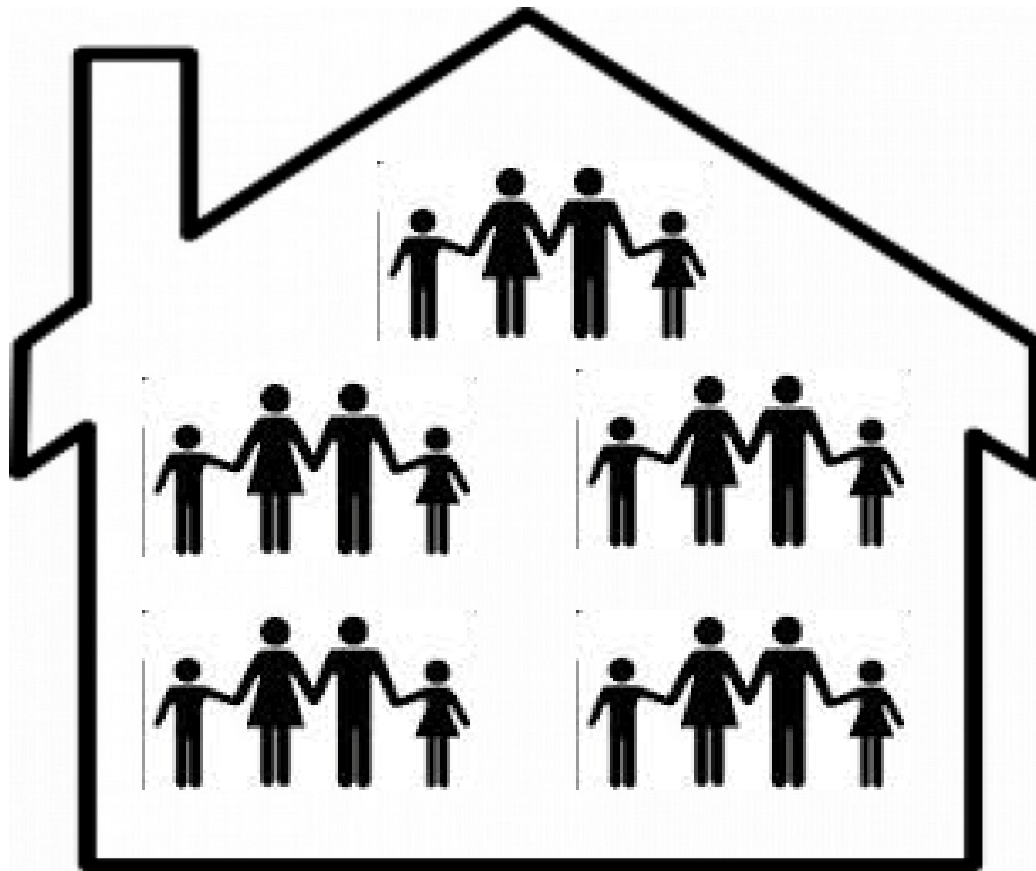

- PV Ownership
- Battery Ownership
- Operation
- Energy Metering
- Invoicing
- Regulation
- Taxes and Fees
-

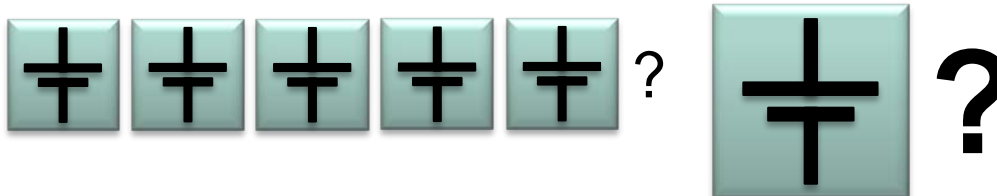

And what about Communities?

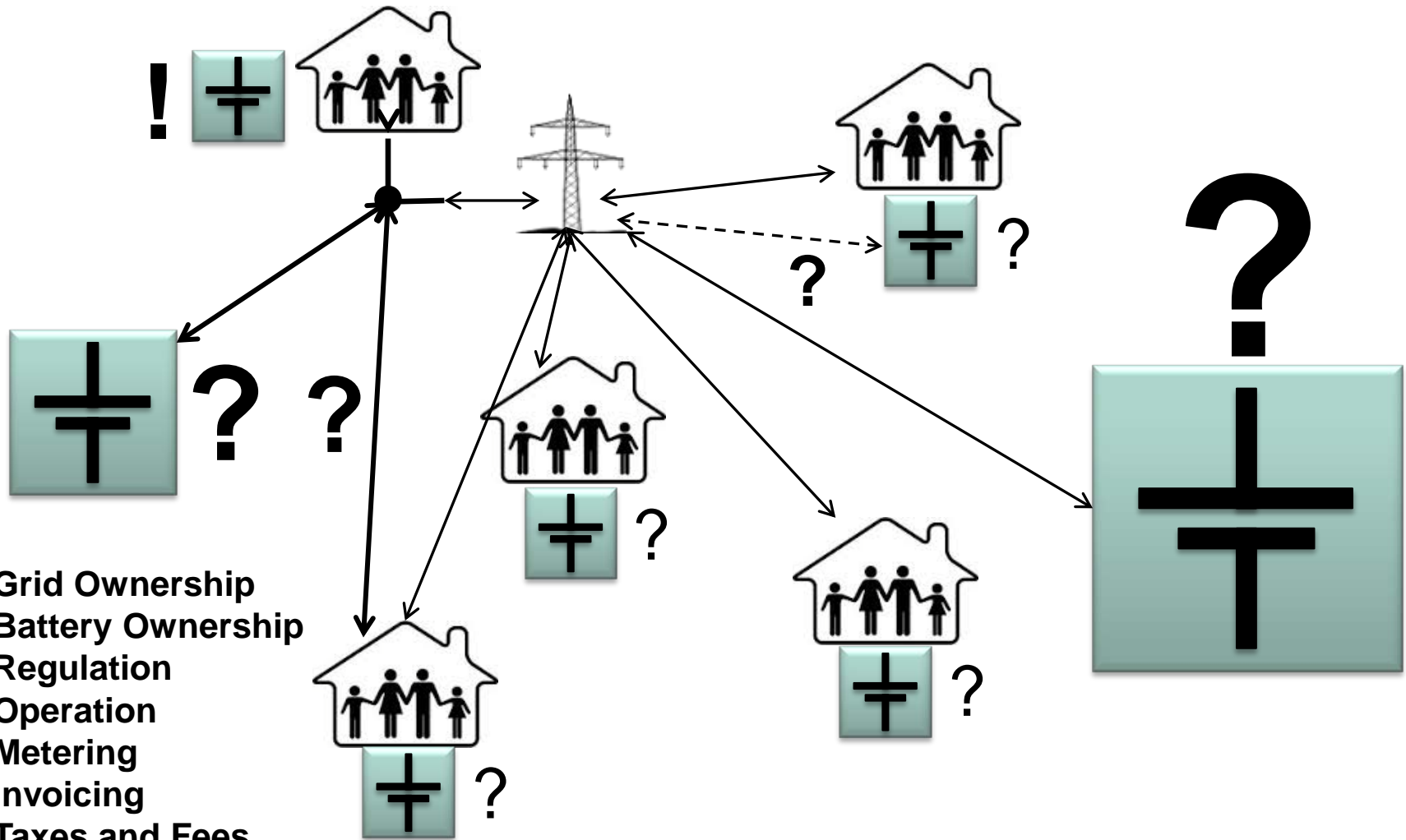

- Grid Ownership
- Battery Ownership
- Regulation
- Operation
- Metering
- Invoicing
- Taxes and Fees
-

Business Cases Exist ONLY with Safe Batteries!



Possible End-of-Life of Home Storage Systems with Non-redundant Disconnecting Switch